



Washing Machine Instruction Manual

DWC-UD121X Series / DWD-UD121X Series

Features

■ **Economic wash system**

Using artificial intelligence, the washer uses minimum energy and water by selecting optimal water lever and washing time.

■ **Low noise system**

The washer minimizes the washing and spinning noises by sensing the amount of laundry.

■ **Child-Lock**

The Child-Lock system has been used to prevent children from pressing any button to change the program during operation.

■ **Nano-silver sterilization washing(Optional)**

By applying very fine silver particles on essential parts inside, the washer sterilizes up to 99.9% as is done by boiling wash.

■ **Air bubble washing(Optional)**

This is an advanced technology that generates millions of air bubbles inside the drum on washing sequence, and the bubbles dissolve the detergent particles completely and cleanse all the soil in clothes gently and neatly.

■ **Waist Care**

Designed by the waist, and the most comfortable angle eject into the laundry is convenient and easy to manipulate.

■ **The World's First Steam White Course**

The Steam White Course save more 50 percent of Electricity, Water, Time than previous White Course.

■ **The World's First Shoes Course**

Enable to wash shoes.

■ **Self-Cleaning Course of Drum.**

Enable to Self-Cleaning of Drum.

■ **Digital Condensing Dry System.**

Condensing Dry System with saving energy. (for DWC-UD121X)

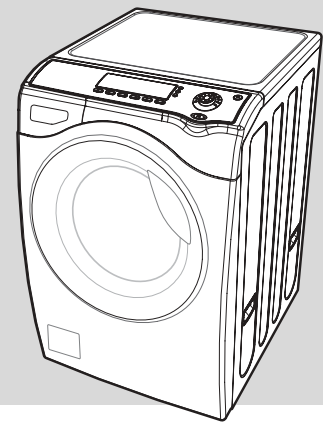

CONTENTS

Page

PARTS AND FEATURES	2
WASHER SAFETY	3
INSTALLATION INSTRUCTIONS	4
INLET HOSE CONNECTION	5
ELECTRICAL REQUIREMENTS	6
OPERATING YOUR WASHER	7
THE FUNCTIONS OF THE CONTROL PANEL	9
WASHING PROGRAM	11
WASHING PROCEDURE AND SELECTION	12
GUIDE FOR OTHER USEFUL PROGRAMS	24
MAINTENANCE	29
HOW TO CLEAN THE FILTER	30
REMOVING STAINS	31
TROUBLE SHOOTING	32
SPECIFICATION	33

A NOTE TO YOU

Thank you for buying a DAEWOO appliance.

DAEWOO washers are easy to use, save time, and help you manage your home better.

This manual contains valuable information about how to operate and maintain your washer property and safely.

Please read it carefully.

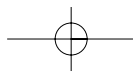

PARTS AND FEATURES



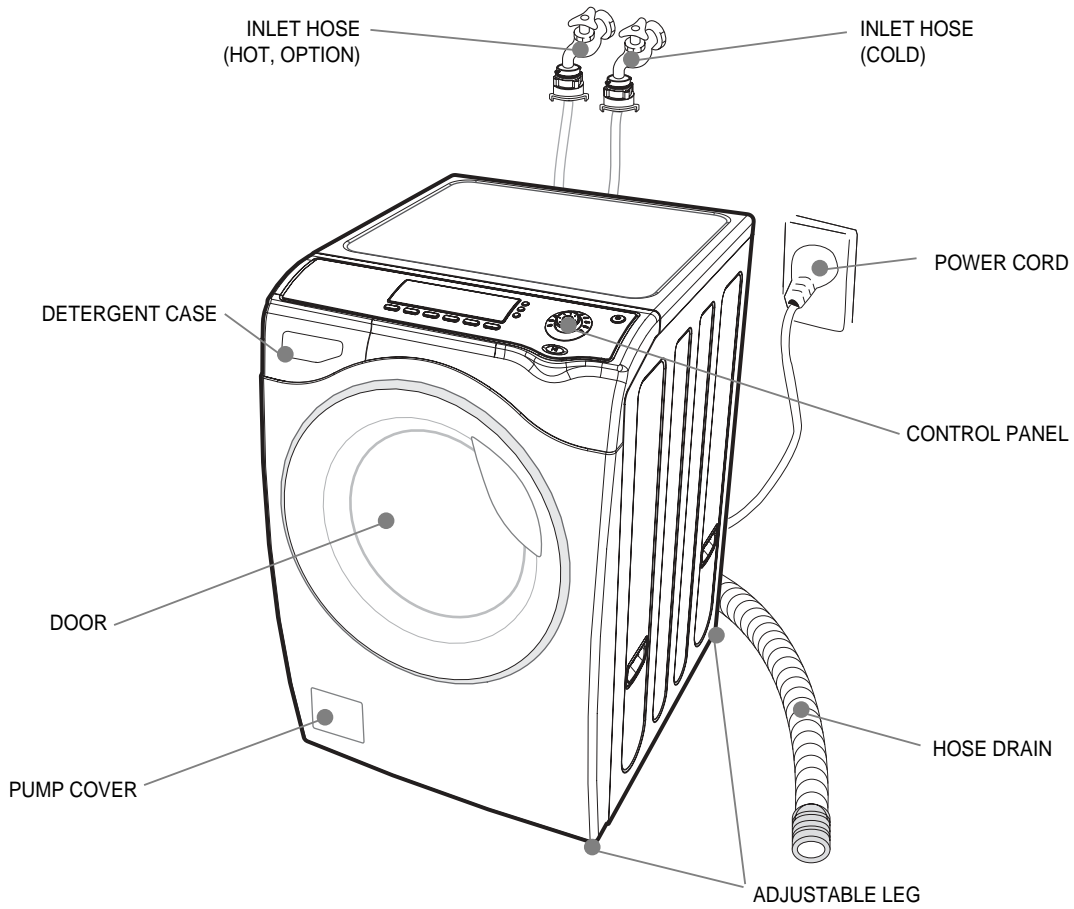

The parts and features of your washer are illustrated on the page. Become familiar with all parts and features before using your washer.

NOTE

The drawings in the book may vary from your washer model. They are designed to show the different features of all models covered by this book, Your model may not include all features.

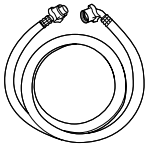

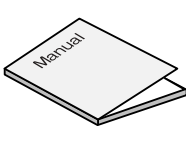
Accessories

Hose drain	Inlet hose	Spanner	Manual	Cap holder
				

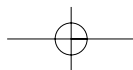

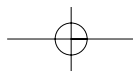

WASHER SAFETY

Save these instructions

Your safety is important to us.

To reduce the risk of fire, electrical shock, or injury when using your washer adhere to the following basic precautions.

Read all instructions before using your washer	
<ul style="list-style-type: none"> • Flammable fluids (dry-cleaning solvents, kerosene, gasoline, etc.) should not be used or stored in or near your washer. Do not add flammable fluids to your wash water. These substances give off vapors that can create a fire hazard or explosion. • After starting a cycle, do not reach into the washer until all motions stop. • Do not tamper with the controls. • The appliance is not intended for use by young children or infirm persons without supervision. • If the supply cord is damaged, it must be replaced by the manufacturer, or its service agent or a similarly qualified person in order to avoid a hazard. • If the appliance is supplied from a cord extension set or electrical portable outlet device it should be positioned so that it is not subjected to splashing or ingress of moisture. 	<p>Please ...</p> <ul style="list-style-type: none"> • Have only a qualified person install, repair, or replace parts on washer. • Maintain washer properly. • Protect washer from the weather and keep it where the temperature will not fall below freezing. • Do not install the washer at a place of extremely high humidity. It could cause an electric shock or a short circuit. • Connect washer to the correct outlet, electrical supply, water supply, and drain supply.

Understanding your responsibilities

- Do not use chlorine bleach and ammonia or acid (such as vinegar or rust remover) in the same wash. Hazardous fumes can form.
- Unplug power supply cord before attempting to service your washer.
- Do not wash fiberglass material.
Small particles can stick to fabrics washed in following loads and cause skin irritation.
- Do not spray water on the control panel of the washer.
It could cause fire or an electric shock.
- In case of the dual valve model, if you connect only cold water inlet valve, while water temperature is selected as hot or warm, there can be water leakage from unconnected water inlet valve.
- This appliance must be grounded.
To avoid electrical shock, use a metal pipe for the ground connection.

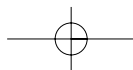

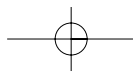

INSTALLATION INSTRUCTIONS

Removing transit bolts

1. Before operating the washer, remove the transit bolts(4ea) along with the rubber.
 - If the bolts are not removed, it may cause heavy vibration, noise and malfunction.

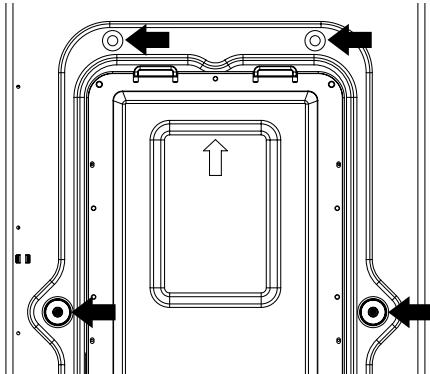

2. Unscrew the 4 bolts with the spanner supplied. Keep the 4 bolts and spanner for future use.
 - Whenever the appliance is transported, the transit bolts must be refitted.

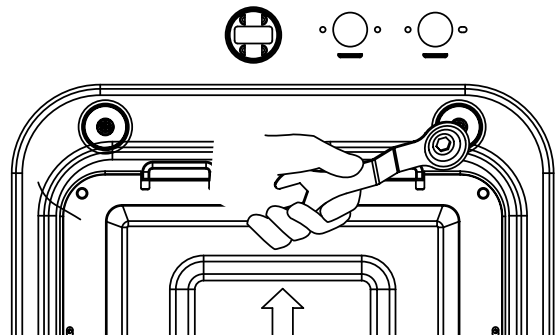

3. Close the holes with the cap holders supplied.

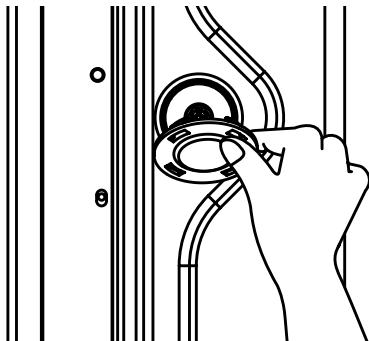

Location of washer

- Check location where the washer will be installed. Make sure you have everything necessary for correct installation.
- Do not place or store your washer below 0°C (32°F) to avoid any damage from freezing.
- Do not place or store laundry products on top of washer at any times.
- Install the washer on the horizontal solid floor.

If the washer is installed on an unsuitable floor, it could make considerable noise, vibrate severely and cause a malfunction. If the washer is not level, adjust leg up or down for horizontal installation.
- Ventilation openings must not be obstructed by carpeting when the washer is installed on a carpeted floor.
- Leave some space (right & left : 2cm, rear : 10cm).
- In case of built-in installation, the distance between top of the washer and bottom of upper plate should be at least 3mm.

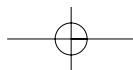
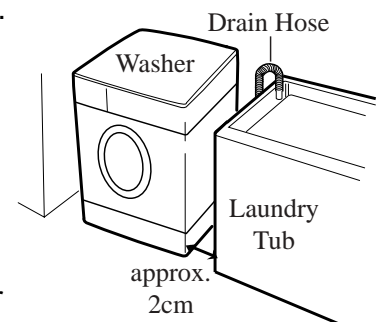

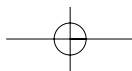

INLET HOSE CONNECTION

The washer should be connected to the water mains using new hose sets and old hose sets should not be reused.



In using only one water tap or in case of only one water inlet valve, connect the inlet hose to the cold water inlet valve.

Option : Be careful not to confuse hot water inlet and cold water inlet.

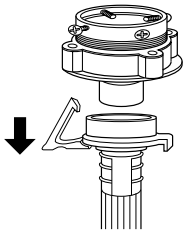
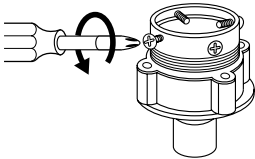
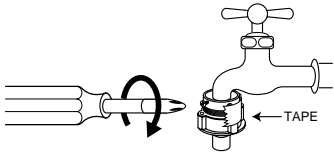
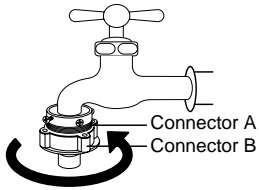
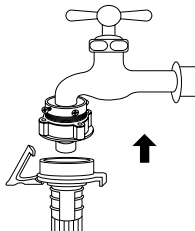
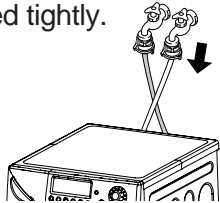
For Ordinary Tap

<p>① Pull down the collar of the inlet hose to separate it from the water tap adapter.</p> 	<p>② Loosen the four screws properly in order to fit into water tap.</p> 	<p>③ Fit the water tap adapter into the water tap and tighten the four screws evenly while pushing up the adapter so that the rubber packing can stick to the water tap tightly.</p> 
<p>④ Remove the tape, and screw connector B into connect A tightly.</p> 	<p>⑤ Connect the inlet hose to the water tap adapter by pulling down the collar of the hose end.</p> 	<p>⑥ Connect the inlet hose adapter of the hose to the water inlet of the washer by turning it clockwise to be fixed tightly.</p>  <p>• Please check the rubber packing present inside the inlet hose adapter of the hose.</p>

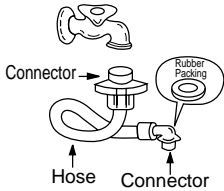
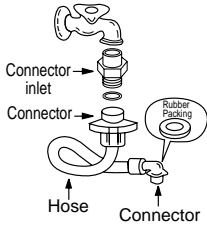
For Screw-Shaped Tap

<p>① Connect the inlet hose to the water tap by screwing the connector tightly.</p> 	<p>② Connect the connector-inlet supplied if necessary.</p> 	<p>③ Connect the inlet hose adapter to the water inlet of a washer and turn it to be fixed.</p>  <p>*Check the packing in the inlet</p>
---	---	--

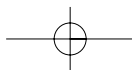

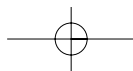

ELECTRICAL REQUIREMENTS

WARNING Electrical shock hazard : Failure to follow these instructions could result in death or serious injury.	
<ul style="list-style-type: none"> • Electrical earth is required on this washer • If it does not fit the outlet, have a proper outlet installed by a qualified electrician. 	<ul style="list-style-type: none"> • Don't earth to a gas pipe. • Don't change the power supply cord plug. • Check with a qualified electrician if you are not sure the washer is properly earthed.
Recommended earthing method	
	<p>For your personal safety, this washer must be earthed. This washer is equipped with a power supply cord 'A' having a earthing plug 'B'. To minimize possible shock hazard, the cord must be plugged into a mating earthing-type wall receptacle 'C'. If a mating wall receptacle is not available, it is the personal responsibility and obligation of the customer to have the proper earthed wall receptacle installed by a qualified electrician.</p>

Drain system

- Never forget to install drain hose before operating your washer.
- Open the packing box, and there is a drain hose inside the drum.
- Connect the drain hose to the drain outlet at the back side of the washer.
- Proper securing of the drain hose will protect the floor from damage due to water leakage.
- When the drain hose is too long, do not force it back into the washer. This will cause abnormal noise.
- For Pump Model
Top of laundry tub must be at least 60cm high and no higher than 100cm For Pump Model of washer.

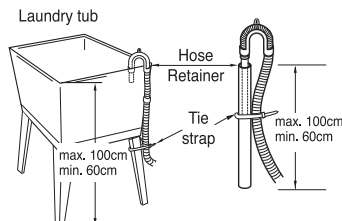
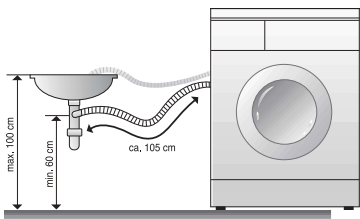

When installing the drain hose to tub(sink), secure it tightly with a string.

For Non-Pump Model

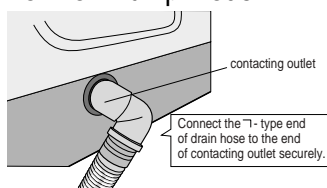

If you need to extend drain hose, contact the sales agent, or service center.



	Height of drain hose	Length of drain hose
if the height of drain hose is elevated in the middle	less than 10cm	less than 1m
If not the height of drain hose is elevated in the middle	-	less than 3m

For extending the drain hose, the type of end of drain hose to be used is not "┐" type, but "—" type.

Level adjustment

- ① If the washer is installed on an unsuitable floor, it could make considerable noise, vibrate and cause a malfunction.

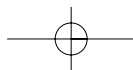

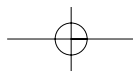

② Adjust the level of washer using adjustable legs.

- Please check if there is any gap between the four adjustable legs and the floor.
- Turning adjustable legs by the enclosed spanner, adjust the level of washer and make it sure that there is no swaying of washer.
- After the adjustment is finished, turn the fixing nuts up tightly so that the washer maintains the adjustment.

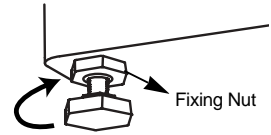
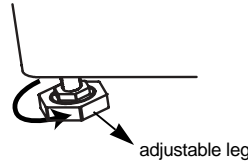

③ Make it sure that the washer does not sway when you press down the four corners of the washer's top plate.

NOTE
There should be no swaying of washer and all the adjustable legs should stick to the floor closely.



OPERATING YOUR WASHER

To obtain the best washing results, you must operate your washer properly. This section gives you this important information.

Preparing clothes for washing	
<ul style="list-style-type: none"> • Close zippers, snaps, and hooks to avoid snagging other items. Remove pin, buckles, and other hard objects to avoid scratching the washer interior. • Empty pockets and pull them inside out. 	<ul style="list-style-type: none"> • Turn down cuffs and turn synthetic knits inside out to avoid pilling. • Tie strings and sashes to avoid tangling. • Treat spots and stains. (See "Removing stains" on page 21)

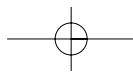
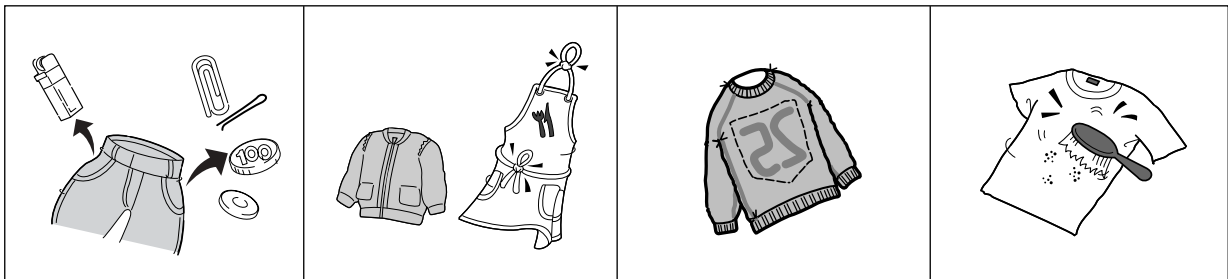

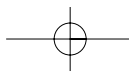

Sorting

- Separate heavily soiled items from lightly soiled ones, even if they would normally be washed together.
- Separate dark colors from light colors, colorfast items from non-colorfast item.

Soil (Heavy, Normal, Light)	Separate clothes according to amount of soil.
Color (White, Lights, Darks)	Separate white clothes from colored clothes.
Lint (Lint producers, Collectors)	Wash lint producers and lint collectors separately.

Loading

- | | |
|---|---|
| <ul style="list-style-type: none"> • Drop items into washer loosely. Items should move easily through wash water for best cleaning and wrinkle-free results. • Load washer properly and select correct load size setting.
Overloading and selecting a setting too small for the wash load can : <ul style="list-style-type: none"> - Cause poor cleaning - Increase wrinkling - Create excessive lint - Wear out items faster (because of pilling) | <ul style="list-style-type: none"> • Mix large and small items in each load. Load evenly to maintain washer balance. An unbalanced load can make the washer vibrate during spin. • Reduce wash time when using a small load size setting. Load with only a few small items needs less wash time. • Use a large load size setting to reduce wrinkling with permanent press clothes and some synthetic knits. These items should have more room to move in the water than heavy items. (towels, jeans) |
|---|---|



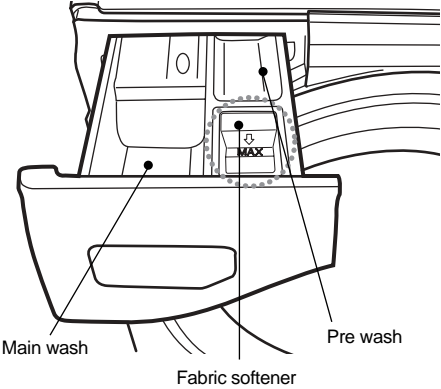

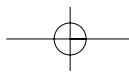







Adding detergent

<p>① Detergent case</p> 	<p>② Adding fabric softener</p> <ul style="list-style-type: none"> • If desired, add measured liquid fabric softener to the softener inlet. • Pour liquid fabric softener into the dispenser using the amount recommended on the package. • Do not exceed the maximum fill line. Overfilling can cause early dispensing of the fabric softener which could stain clothes. • Do not open the detergent case when water is supplied. • Avoid pouring fabric softener directly on the clothes.
---	--





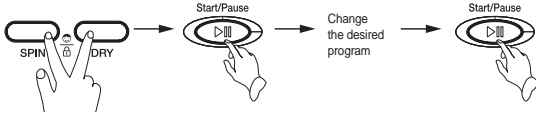









THE FUNCTION OF CONTROL PANEL (DWC-UD121X)



	<p>Press this switch to turn the power 'ON' or 'OFF'.</p>
	<p>Operation and temporary stop is repeated as it is pressed. When you want to change program in operating; Press the 'Start/Pause' button → Select the program that you want to change → Press the 'Start/Pause' button again.</p>
	<p>You can select the course you want and each lamp is turned on when that course is selected.</p>
	<p>You can select the wash course you want and each lamp is turned on when that course is selected. As this button is pressed, the wash course is selected by Soak → Prewash → Main Wash.</p>
	<p>You can select the rinse time(s) you want and each lamp is turned on when that course is selected. As this button is pressed, the rinse time(s) is selected by '1' → 'Add water' → '2' → 'Add water' →... → '5' → 'Add water' → '1'.</p>
	<p>You can select the spin speed you want and each lamp is turned on when that course is selected.</p>
	<p>It can be used to pre-engage time for wash from 1 hr to 12 hrs.</p>
	<p>It can be used to adjust water temperature according to types of the load to be washed. As this button is pressed, water temperature is selected by Cold → 30°C → 40°C → 60°C → 95°C.</p>
	<p>You can select the dry condition you want and each lamp is turned on when that course is selected.</p>
	<p>Use this function when you want to protect any accident occurring from handling of washer by a child. During an operation of washer, press 'SPIN' and 'DRY' buttons simultaneously during 3 second. In this mode will be set successfully, CHL and remain time will be shown on PCB board alternately. In Child Lock mode, no button functions except Power button. If you want to set this mode, press 'SPIN' and 'DRY' buttons simultaneously during 3 second. And if you want to release this mode, press 'SPIN' and 'DRY' buttons simultaneously again during 3 second.</p> <p>If you want to change to the desire program, while this mode is working;</p> <ol style="list-style-type: none"> 1. Press 'SPIN' and 'DRY' buttons simultaneously again during 3 second. 2. Press the 'Start/Pause' button. 3. Select the desired program and press the 'Start/Pause' button again.  <p>* The Child Lock will be cancelled when power is off.</p>
	<p>If you want to open Door intentionally during operation, press the 'Start/Pause' button and press again 'Door unlock' button. In this case, Δ signal will be appeared on PCB board, then you can open Door after cooling inside Tub temperature and draining water, also no button functions except Power button.</p>

THE FUNCTION OF CONTROL PANEL (DWD-UD121X)

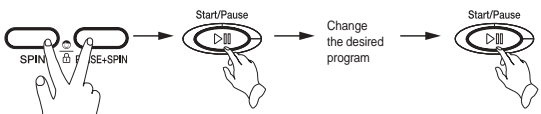

	<p>Press this switch to turn the power 'ON' or 'OFF'.</p>
	<p>Operation and temporary stop is repeated as it is pressed. When you want to change program in operating; Press the 'Start/Pause' button → Select the program that you want to change → Press the 'Start/Pause' button again.</p>
	<p>You can select the course you want and each lamp is turned on when that course is selected.</p>
	<p>You can select the wash course you want and each lamp is turned on when that course is selected. As this button is pressed, the wash course is selected by Soak → Prewash → Main Wash.</p>
	<p>You can select the rinse time(s) you want and each lamp is turned on when that course is selected. As this button is pressed, the rinse time(s) is selected by '1' → 'Add water' → '2' → 'Add water' →... → '5' → 'Add water' → '1'.</p>
	<p>You can select the spin speed you want and each lamp is turned on when that course is selected.</p>
	<p>It can be used to pre-engage time for wash from 1 hr to 12 hrs.</p>
	<p>It can be used to adjust water temperature according to types of the load to be washed. As this button is pressed, water temperature is selected by Cold → 30°C → 40°C → 60°C → 95°C.</p>
	<p>You can select the rinse+spin condition you want and each lamp is turned on when that course is</p>
	<p>Use this function when you want to protect any accident occurring from handling of washer by a child. During an operation of washer, press 'SPIN' and 'RINSE+SPIN' buttons simultaneously during 3 second. If this mode will be set successfully, CHL and remain time will be shown on PCB board alternately. In Child Lock mode, no button functions except Power button. If you want to set this mode, press 'SPIN' and 'RINSE+SPIN' buttons simultaneously during 3 second. And if you want to release this mode, press 'SPIN' and 'RINSE+SPIN' buttons simultaneously again during 3 second. If you want to change to the desire program, while this mode is working; 1. Press 'SPIN' and 'RINSE+SPIN' buttons simultaneously again during 3 second. 2. Press the 'Start/Pause' button. 3. Select the desired program and press the 'Start/Pause' button again.</p>  <p>* The Child Lock will be cancelled when power is off.</p>
	<p>If you want to open Door intensionally during operation, press the 'Start/Pause' button and press again 'Door unlock' button. In this case,  signal will be appeared on PCB board, then you can open Door after cooling insideTub temperature and draining water, also no button functions except Power button.</p>

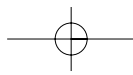

WASHING PROGRAM

Program	Fabric type	Proper Temp.	Default data	Maximum Load
Normal	Colorfast garments (shirts, night dresses, pajamas,..) and lightly soiled white cottons(underwares,..)	40°C (cold,30°C, 60°C)	Wash: main wash Rinse: 2 Spin : Medium Temp.: 40°C	Refer to rating label
Whites	First check whether laundry is machine washable. (white cotton, linen, towel and sheets..)	95°C (fixed)	Wash: main wash Rinse: 3 Spin : Medium Temp.: 95°C	Refer to rating label
Heavy Stain	Heavy soiled clothes (blue-jean,climbing clothes, ruck sack, sports wear,..)	40°C (cold, 30°C, 60°C)	Wash: pre wash Rinse: 3 Spin : Medium Temp.: 40°C	Refer to rating label
Delicate	Delicated laundry easily damaged. (silk, curtains,..)	Cold (fixed, in order to prevent textile damage)	Wash: main wash Rinse: 2 Spin: low Temp.: cold	Refer to rating label
Blanket	Blanket, curtains,..	Cold (fixed, in order to prevent textile damage)	Wash: main wash Rinse: 3 Spin : Medium Temp.: cold	Refer to rating label
Quick 30	Lightly soiled clothes and frequently washing clothes and small amount of clothes.	Cold (fixed)	Wash: main wash Rinse: 1 Spin : Medium Temp.: cold	Less than 3 kg
Memory	Use to memory program you want.			
Tub Clean	Use to clean (and dry for DWC-UD121X) the Tub and Drum.	Cold	Wash: soak Rinse: 2 Spin: low Temp.: cold Dry : Low Temp (DWC-UD121X)	without load.
Steam Whites	enable to white(white cotton, linen, towel, shees..)	40°	Wash :main wash Rinse : 2 Spin : Medium Temp. : 40°C Steam: Strong	Refer to rating label
Sports Shoes	Only sports shoes	40°	Wash :main wash Rinse : 2 Spin : low Temp. : 40°C Dry : Low Temp (DWC-UD121X)	Refer to rating label
Baby Care	Baby Clothes	40°	Wash :main wash Rinse : 4 Spin : Medium Temp. : 40°C Steam : Strong	Refer to rating label
Air Wash (DWC-UD121X)	disinfect or deodorize	Cold	Dry	Refer to rating label

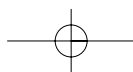

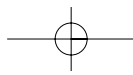

WASHING PROCEDURE AND SELECTION

1. NORMAL PROGRAM

1	<p>Put the laundry into the Drum and put the detergent and softener into the detergent case. Then close the Door.</p> <ul style="list-style-type: none"> • Put the detergent into the main wash room(I I marking). • Softener should be below 'MAX' level. • Put the detergent into the pre wash room(I marking) only if you want to add prewash. • When you want to use bleach, put it into the main wash room (I I marking) with detergent.
2	<p>Press the Power button.</p> <ul style="list-style-type: none"> • The LED shows only '- --' signal.
3	<p>Select the 'NORMAL' program using the program selection dial.</p> <ul style="list-style-type: none"> • If you press 'Start/Pause' button after pressing Power button without selecting program, the 'NORMAL' program is selected as default program. • Main wash' and '2' times rinse and 'Medium' spin speed and '40°C' water temperature are selected automatically. • If you want to change the 'Washing course' and 'Rinse time(s)' and 'Spin speed' and 'water temperature', select program what you want to change by pressing each button.
4	<p>Press the 'Start/Pause' button.</p> <ul style="list-style-type: none"> • The washer will be operated with locking Door and supplying water after sensing the amount of laundry automatically.

Note

- If you want to change the setting program during operation, press the 'Start/Pause' button to hold the operation and change the program you want to change by pressing each corresponding button.
- Water temperature '95°C' is not selected in order to prevent clothes from damaging.
- If you want to add the clothes during operation, press 'Start/Pause' button and 'Door unlock' button, then open the Door and put the clothes into the Drum and then close Door and press 'Start/Pause' button again.

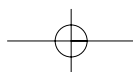

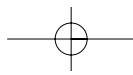

2. WHITES PROGRAM

1	<p>Put the laundry into the Drum and put the detergent and softener into the detergent case Then close the Door</p> <ul style="list-style-type: none"> • Put the detergent into the main wash room(I I marking . • Softener should be below 'MAX' level. • Put the detergent into the pre wash room(I marking) only if you want to add prewash. • When you want to use bleach, put it into the main wash room (I I marking) with detergent
2	<p>Press the Power button</p> <ul style="list-style-type: none"> • The LED shows only '- --' signal
3	<p>Select the 'WHITE' program using the program selection dial.</p> <ul style="list-style-type: none"> • If you press 'Start/Pause' button after pressing Power button without selecting program, the 'NORMAL' program is selected as default program. • 'Main wash' and '3' times rinse and 'Medium' spin speed and '95°C' water temperature are selected automatically. • If you want to change the 'Washing course' and 'Rinse time(s)' and 'Spin speed' , select program what you want to change by pressing each button.
4	<p>Press the 'Start/Pause' button.</p> <ul style="list-style-type: none"> • The washer will be operated with locking Door and supplying water after sensing the amount of laundry automatically.

Note

- If you want to change the setting program during operation, press the 'Start/Pause' button to hold the operation and change the program you want to change by pressing each corresponding button.
- Water temperature is set only to '95°C'.
- If you want to add the clothes during operation, press 'Start/Pause' button and 'Door unlock' button, then open the Door and put the clothes into the Drum and then close Door and press 'Start/Pause' button again.
- If much SUDS is happened during operation, the washer will clean SUDS automatically.

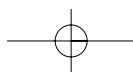

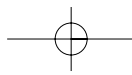

3. HEAVY STAIN PROGRAM

1	<p>Put the laundry into the Drum and put the detergent and softener into the detergent case. Then close the Door.</p> <ul style="list-style-type: none"> • Put the detergent into the main wash room(I I marking) and prewash room(I marking) in the detergent case. • Softener should be below 'MAX' level. • When you want to use bleach, put it into the main wash room (I I marking) with detergent.
2	<p>Press the Power button.</p> <ul style="list-style-type: none"> • The LED shows only '- --' signal.
3	<p>Select the 'HEAVY STRAIN' program using the program selection dial.</p> <ul style="list-style-type: none"> • If you press 'Start/Pause' button after pressing Power button without selecting program, the 'NORMAL' program is selected as default program. • 'Pre wash' and '3' times rinse and 'Medium' spin speed and '40°C' water temperature are selected automatically. • If you want to change the 'Washing course' and 'Rinse time(s)' and 'Spin speed' and 'water temperature', select program what you want to change by pressing each button.
4	<p>Press the 'Start/Pause' button.</p> <ul style="list-style-type: none"> • The washer will be operated with locking Door and supplying water.

Note

- If you want to change the setting program during operation, press the 'Start/Pause' button to hold the operation and change the program you want to change by pressing each corresponding button.
- Water temperature '95°C' is not selected in order to prevent clothes from damaging.
- If you want to add the clothes during operation, press 'Start/Pause' button and 'Door unlock' button, then open the Door and put the clothes into the Drum and then close Door and press 'Start/Pause' button again.

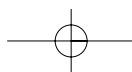

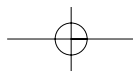

4. DELICATE PROGRAM

1	<p>Put the laundry into the Drum and put the detergent and softener into the detergent case. Then close the Door.</p> <ul style="list-style-type: none"> • Put the detergent into the main wash room(I I marking) in the detergent case. • Softener should be below 'MAX' level. • When you want to use bleach, put it into the main wash room (I I marking) with detergent.
2	<p>Press the Power button.</p> <ul style="list-style-type: none"> • The LED shows only '- --' signal.
3	<p>Select the 'DELICATE' program using the program selection dial.</p> <ul style="list-style-type: none"> • If you press 'Start/Pause' button after pressing Power button without selecting program, the 'NORMAL' program is selected as default program. • 'Main wash' and '2' times rinse and 'low' spin speed and 'Cold' water temperature are selected automatically. • If you want to change the 'Washing course' and 'Rinse time(s)' and 'Spin speed', select program what you want to change by pressing each button.
4	<p>Press the 'Start/Pause' button.</p> <ul style="list-style-type: none"> • The washer will be operated with locking Door and supplying water.

Note

- If you want to change the setting program during operation, press the 'Start/Pause' button to hold the operation and change the program you want to change by pressing each corresponding button.
- Water temperature 'Cold' is only selected in order to prevent delicate clothes from damaging.
- Spin speed 'low' and 'Rinse Hold' are only selectable.
- DRY function is not selected(option function).
- DELAY START is not selected.
- SOAK and Pre Wash in wash program are not selected.
- If you want to add the clothes during operation, press 'Start/Pause' button and 'Door unlock' button, then open the Door and put the clothes into the Drum and then close Door and press 'Start/Pause' button again.

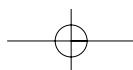

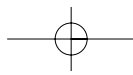

5. BLANKET PROGRAM

1	<p>Put the laundry into the Drum and put the detergent and softener into the detergent case. Then close the Door.</p> <ul style="list-style-type: none"> • Put the detergent into the main wash room(I I marking) in the detergent case. • Softener should be below 'MAX' level. • When you want to use bleach, put it into the main wash room (I I marking) with detergent.
2	<p>Press the Power button.</p> <ul style="list-style-type: none"> • The LED shows only '- --' signal.
3	<p>Select the 'BLANKET' program using the program selection dial.</p> <ul style="list-style-type: none"> • If you press 'Start/Pause' button after pressing Power button without selecting program, the 'NORMAL' program is selected as default program. • 'Main wash' and '3' times rinse and 'Medium' spin speed and 'Cold' water temperature are selected automatically. • If you want to change the 'Washing course' and 'Rinse time(s)' and 'Spin speed', select program what you want to change by pressing each button.
4	<p>Press the 'Start/Pause' button.</p> <ul style="list-style-type: none"> • The washer will be operated with locking Door and supplying water.

Note

- If you want to change the setting program during operation, press the 'Start/Pause' button to hold the operation and change the program you want to change by pressing each corresponding button.
- Water temperature 'Cold' is only selected in order to prevent delicate clothes from damaging.
- Spin speed 'low' and 'medium' and 'Rinse Hold' are only selectable.
- DRY function is not selected(option function).
- DELAY START is not selected.
- SOAK and Pre Wash in wash program are not selected.
- If you want to add the clothes during operation, press 'Start/Pause' button and 'Door unlock' button, then open the Door and put the clothes into the Drum and then close Door and press 'Start/Pause' button again.

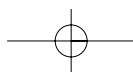

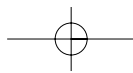

6. QUICK 30 PROGRAM

1	<p>Put the laundry into the Drum and put the detergent and softener into the detergent case. Then close the Door.</p> <ul style="list-style-type: none"> • Put the detergent into the main wash room(I I marking) in the detergent case. • Softener should be below 'MAX' level. • When you want to use bleach, put it into the main wash room (I I marking) with detergent.
2	<p>Press the Power button.</p> <ul style="list-style-type: none"> • The LED shows only '- --' signal.
3	<p>Select the 'QUICK 30' program using the program selection dial.</p> <ul style="list-style-type: none"> • If you press 'Start/Pause' button after pressing Power button without selecting program, the 'NORMAL' program is selected as default program. • 'Main wash' and '1' times rinse + add water and 'Medium' spin speed and 'Cold' water temperature (and 'Cupboard' dry condition) are selected automatically. • If you want to change the 'Washing course' and 'Rinse time(s)' and 'Spin speed' and 'water temperature', select program what you want to change by pressing each button.
4	<p>Press the 'Start/Pause' button.</p> <ul style="list-style-type: none"> • The washer will be operated with locking Door and supplying water.

Note

- The appropriate amount of laundry is below 3 kg.
- If you want to change the setting program during operation, press the 'Start/Pause' button to hold the operation and change the program you want to change by pressing each corresponding button.
- Water temperature only Cold.
- Spin speed 'extra/high' is not selected.
- All wash program are not selected except main wash..
- If you want to add the clothes during operation, press 'Start/Pause' button and 'Door unlock' button, then open the Door and put the clothes into the Drum and then close Door and press 'Start/Pause' button again.

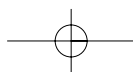

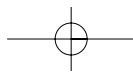

7. MEMORY PROGRAM

1	<p>Put the laundry into the Drum and put the detergent and softener into the detergent case. Then close the Door.</p> <ul style="list-style-type: none"> • Put the detergent into the main wash room(I I marking) . • Softener should be below 'MAX' level. • Put the detergent into the pre wash room(I marking) only if you want to add prewash. • When you want to use bleach, put it into the main wash room (I I marking) with detergent.
2	<p>Press the Power button.</p> <ul style="list-style-type: none"> • The LED shows only '- --' signal.
3	<p>Select the 'MEMORY' program using the program selection dial.</p> <ul style="list-style-type: none"> • If you press 'Start/Pause' button after pressing Power button without selecting program, the 'NORMAL' program is selected as default program. • If you want to memorize the 'Washing program' and 'Washing course' and 'Rinse time(s)' and 'Spin speed' and 'water temperature' (and 'Dry condition'), select somethings what you want to change by pressing each button and using the program selection dial.
4	<p>Press the 'Start/Pause' button.</p> <ul style="list-style-type: none"> • The washer will be operated with locking Door and supplying water.

Note

- If you start memorized program, this data will be saved automatically.
- If you want to change the setting program during operation, press the 'Start/Pause' button to hold the operation and change the program you want to change by pressing each corresponding button.
- If you want to add the clothes during operation, press 'Start/Pause' button and 'Door unlock' button, then open the Door and put the clothes into the Drum and then close Door and press 'Start/Pause' button again.

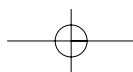

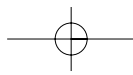

8. TUB CLEAN PROGRAM

1	Press the Power button. • The LED shows only '- -' signal.
2	Select the 'TUB CLEAN' program using the program selection dial. • If you press 'Start/Pause' button after pressing Power button without selecting program, the 'NORMAL' program is selected as default program. • 'Soak' and '2' times rinse and 'low' spin speed and 'Cold' water temperature (and 'Low Temp' dry condition for DWC-UD121X) are selected automatically.
3	Press the 'Start/Pause' button. • The washer will be operated with locking Door and supplying water.

Note

- All programs are not selectable except rinse time(s).
- DELAY START is not selected.
- Use this program WITHOUT load.
- The appropriate cleaning time is one time per a month.

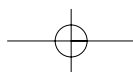

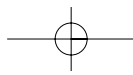

9. STEAM WHITES

1	<p>Put the laundry into the Drum and put the detergent and softener into the detergent case. Then close the door.</p> <ul style="list-style-type: none"> • Put the detergent into the main wash room(II marking). • Softener should be below 'MAX' level. • Put the detergent into the prewash room only if you want to add prewash. • When you want to use bleach put it into the main wash room with detergent
2	<p>Press the Power button</p> <ul style="list-style-type: none"> • The LED shows only '- --' signal.
3	<p>Select the 'Steam Whites' program using the program selection dial</p> <ul style="list-style-type: none"> • Main wash and 2 times rinse and 'Medium' spin speed and 40°C water temperature "Steam : Strong" are selected automatically. • If you want to change the 'Washing course' and 'Rinse time' and Spin speed' and 'water temperature',select program what you want to change by pressing each button.
4	<p>Press the 'Start/Pause' button</p> <ul style="list-style-type: none"> • The washer will be operated with locking door and supplying water after sensing the amount of laundry automatically.

Note

- If you want to change the setting program during operation, press the 'Start/Pause' button to hold the operation and change the program you want to change by pressing each corresponding button.
- If you want to add the clothes during operation, press 'Start/Pause' button and 'Door unlock' button, then open the door and put the clothes into the drum and then close door and press 'Start/Pause' button again.

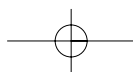

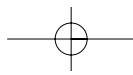

10. SPORTS SHOES

1	<p>Put the laundry into the Drum and put the detergent and softener into the detergent case. Then close the door.</p> <ul style="list-style-type: none"> • Put the detergent into the main wash room and prewash room in the detergent case. • When you want to use bleach put it into the main wash room with detergent
2	<p>Press the Power button</p> <ul style="list-style-type: none"> • The LED shows only '- -' signal.
3	<p>Select the 'Sports shoes' program using the program selection dial</p> <ul style="list-style-type: none"> • Main wash and 2 times rinse and low spin speed and 40°C water temperature (Dry : Low Temp for DWC-UD121X) are selected automatically. • If you want to change the 'Washing course' and 'Rinse time' and Spin speed' and 'water temperature',select program what you want to change by pressing each button.
4	<p>Press the 'Start/Pause' button</p> <ul style="list-style-type: none"> • The washer will be operated with locking door and supplying water after sensing the amount of laundry automatically.

Note

- Please wash only sports shoes.
- If you wash boots or shoes, clothes are damaged.

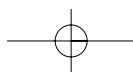

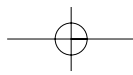

11. BABY CARE

1	<p>Put the laundry into the Drum and put the detergent and softener into the detergent case. Then close the door.</p> <ul style="list-style-type: none"> • Put the detergent into the main wash room(II marking). • Softener should be below 'MAX' level. • When you want to use bleach put it into the main wash room with detergent
2	<p>Press the Power button</p> <ul style="list-style-type: none"> • The LED shows only '- --' signal.
3	<p>Select the 'Baby Care' program using the program selection dial</p> <ul style="list-style-type: none"> • Main wash and 4 times rinse and 'Medium' spin speed and 40°C water temperature "Steam : Strong" are selected automatically. • If you want to change the 'Washing course' and 'Rinse time' and Spin speed' and 'water temperature',select program what you want to change by pressing each button.
4	<p>Press the 'Start/Pause' button</p> <ul style="list-style-type: none"> • The washer will be operated with locking door and supplying water after sensing the amount of laundry automatically.

Note

- If you want to change the setting program during operation, press the 'Start/Pause' button to hold the operation and change the program you want to change by pressing each corresponding button.
- If you want to add the clothes during operation, press 'Start/Pause' button and 'Door unlock' button, then open the door and put the clothes into the drum and then close door and press 'Start/Pause' button again.
- Please wash seperated colorful clothes

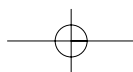

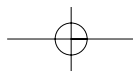

12. AIR WASH (for DWC-UD121X)

1	Put the laundry into the Drum, Then close the door. Then close the door.
2	Press the Power button • The LED shows only '- -' signal.
3	Select the 'Air Wash' program using the program selection dial • Dry
4	Press the 'Start/Pause' button • The washer will be operated with locking door and supplying water after sensing the amount of laundry automatically.

Note

- Please use under 4 kg
- Air wash is for disinfect or deodorize.
- If you want to add the clothes during operation, press 'Start/Pause' button and 'Door unlock' button, then open the door and put the clothes into the drum and then close door and press 'Start/Pause' button again.

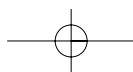

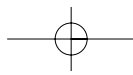

GUIDE FOR OTHER USEFUL PROGRAMS

* DELAY START(RESERVED WASHING)

1	<p>Put the laundry into the Drum and put the detergent and softener into the detergent case. Then close the Door.</p> <ul style="list-style-type: none"> • Put the detergent into the main wash room(I I marking) and prewash room(I marking) in the detergent case. • Softener should be below 'MAX' level. • Put the detergent into the pre wash room(I marking) only if you want to add prewash. • When you want to use bleach, put it into the main wash room (I I marking) with detergent.
2	<p>Press the Power button.</p> <ul style="list-style-type: none"> • The LED shows only '- --' signal.
3	<p>Select the program using the program selection dial.</p> <ul style="list-style-type: none"> • If you press 'Start/Pause' button after pressing Power button without selecting program, the 'NORMAL' program is selected as default program. • Select the 'Washing course' and 'Rinse time(s)' and 'Spin speed' and 'water temperature' by pressing each corresponding button.
4	<p>Press the 'DELAY START' button.</p> <ul style="list-style-type: none"> • The 'Time Delay' LED is to be lighting. • Select the time delay time you want from 1 hour to 12 hours by pressing button. • The displayed time shows program finishing time.
5	<p>Press the 'Start/Pause' button.</p> <ul style="list-style-type: none"> • If you make this program successfully, only '<i>Time Delay</i>' and '<i>Lock</i>' LED are lighting.

Note

- If you want to check the selected program, press the 'Start/Pause' button again.
- Preparing washing before starting 'Time Delay';
 - Turn on the water tap.
 - Load laundry and close Door.
 - Place the detergent and fabric softner in the detergent case.
- The actual time of finishing is a little different with your selecting time because of water supply condition and selected water temperature,....
- 'DELICATE' and 'DRUM CLEANING' program are not select 'Time Delay'.
- Adding clothes during 'Time Delay' operation is not allowed.

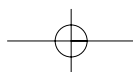

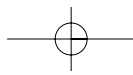

*** ONLY WASH**

1	Put the laundry into the Drum and put the detergent and softener into the detergent case. Then close the Door.
2	Press the Power button. • The LED shows only '- --' signal.
3	Select the 'WASH COURSE' you want by pressing 'WASH' button. • The 'NORMAL' program is selected automatically.
4	Press the 'Start/Pause' button. • The washer will be operated with locking Door and supplying water.

*** ONLY RINSE**

1	Put the laundry into the Drum and put the detergent and softener into the detergent case. Then close the Door.
2	Press the Power button. • The LED shows only '- --' signal.
3	Select the 'RINSE' time(S) you want by pressing 'RINSE' button. • The 'NORMAL' program is selected automatically.
4	Press the 'Start/Pause' button. • The washer will be operated with locking Door and supplying water.

*** ONLY SPIN**

1	Put the laundry into the Drum and close the Door.
2	Press the Power button. • The LED shows only '- --' signal.
3	Select the 'SPIN CONDITION' you want by pressing 'SPIN' button. • The 'NORMAL' program is selected automatically. • The water temperature is selected to 'Cold' automatically.
4	Press the 'Start/Pause' button. • The washer will be operated with locking Door.

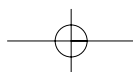

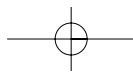

*** DRY (for DWC-UD121X)**

1	Put the laundry into the Drum and close the Door.
2	Press the Power button. • The LED shows only '- --' signal.
3	Select the 'DRY CONDITION' you want by pressing 'DRY' button. As this button is pressed, the dry condition is selected by 'Cupboard' → 'Very' → 'Time(1:00, 1:30, 2:00)' → OFF → 'Low Temp' → 'Iron' → 'Cupboard'
4	Press the 'Start/Pause' button. • The washer will be operated with locking Door.

Note

- Do not use the detergent and softener.
- Cold water tap should be opened.
- After finishing this program, [3333] is showed on PCB board alternately and the smoothing creases program is conducted during 30 minute and then power is OFF.
- 'DELICATE' and 'BLANKET' program are not select 'DRY'.
- Be careful the high temperature of laundry when put out clothes.
- A little shrinkage and deformation will be possibly happened after drying, so check clothes whether dry or not previously
- If the dry performance is poor, change the selecting temperature.
- If you want to dry with wash, after selecting program, press the 'DRY' button then press 'Start/Pause' button.

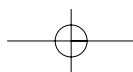

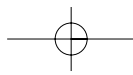

*** RINSE+SPIN (for DWD-UD121X)**

1	<p>Put the laundry into the Drum and put softener into the detergent case. Then close the Door.</p> <ul style="list-style-type: none"> • Softener should be below 'MAX' level.
2	<p>Press the Power button.</p> <ul style="list-style-type: none"> • The LED shows only '- -' signal.
3	<p>Select the program you want using the program selection dial.</p> <ul style="list-style-type: none"> • If you press 'RINSE+SPIN' button without selecting program, the 'NORMAL' program is selected as default program.
4	<p>Press the 'RINSE+SPIN' button.</p> <ul style="list-style-type: none"> • '1' time rinse and '800' rpm spin speed and 'Cold' water temperature are selected automatically. • '400' rpm spin speed is selected in 'DELICATE' program. • If you want to change the Rinse time(s) and Spin condition, press each corresponding button.
5	<p>Press the 'Start/Pause' button.</p> <ul style="list-style-type: none"> • The washer will be operated with locking Door.

Note

- The water temperature selecting is possible during this process.
- You can't use when you select 'QUICK 30' or 'TUB CLEAN' course.
- In 'DELICATE' course, spin speed selectable only 'Low' or 'Rinse Hold'.
- In 'BLANKET' course, spin speed selectable only 'Medium' or 'Low' or 'Rinse Hold'.

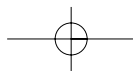

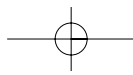

* STEAM

1	<p>Put the laundry into the Drum and put the detergent and softener into the detergent case. Then close the Door.</p> <ul style="list-style-type: none"> • Put the detergent into the main wash room(I I marking). • Softener should be below 'MAX' level. • Put the detergent into the pre wash room only if you want to add prewash. • When you want to use bleach, put it into the main wash room (I I marking) with detergent.
2	<p>Press the Power button.</p> <ul style="list-style-type: none"> • The LED shows only '- --' signal.
3	<p>Select the 'Steam Option' you want by touching 'Steam' button.</p> <ul style="list-style-type: none"> • If you press 'Start/Pause' button after pressing Power button without selecting program, the 'NORMAL' program is selected as default program. • Select the 'Washing course' and 'Rinse time(s)' and 'Spin speed' and 'water temperature' by pressing each corresponding button.
4	<p>Press the 'Start/Pause' button.</p>

Note

- Use to wash clothes with heavily stained and such clothes as underwear and baby clothes
- Among Water Temperature options, 'cold' and '95°...' can not be selected .
- Among Wash Course options, 'Soak' cannot be selected.
- Steam cannot be selected at 'DELICATE', 'Blanket', 'Drum Drying', 'Quick 30' program.
- Steam being selected, 2 Rinse time is selected of Rinse Time Options automatically.
But other Rinse Time can be selected by touching 'Rinse Time' Button.

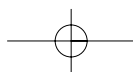

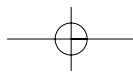

MAINTENANCE

Proper care of your washer can extend its life. This section explains how to care for your washer properly and safely.

Cleaning your washer

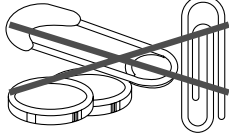
Exterior	Interior
<p>Wipe up detergent, bleach, and other spills with a soft, damp cloth or sponge as they occur. Occasionally wipe the outside of the washer to keep its looking like new one.</p> 	<p>Clean interior with 250ml of chlorine bleach mixed with 500ml of detergent. Run washer through a complete cycle. Repeat this process if necessary.</p>
<p>Do not put sharp or metal object in your washer, or they can damage the finish. Check all pockets for pins, clips, money, bolts, nuts, etc. Do not lay these objects in your washer after emptying pockets.</p> 	

Winter storage or moving care

Install and store your washer where it will not freeze. Because some water may stay in the hoses, freezing can damage your washer.

If you store or move your washer during freezing weather, winterize it.

To winterize washer	To use washer again
<ul style="list-style-type: none"> • Turn off water faucet. • Disconnect and drain water inlet hoses. • Run washer on a drain and spin setting (see page 10) for 1 minute. • Unplug the power supply cord. 	<ul style="list-style-type: none"> • Flush water pipes and hoses. • Reconnect water inlet hoses. • Turn on water faucet. • Reconnect power supply cord.

Non-use or vacation care

Operate your washer only when you are at home.

If you are on vacation or don't use your washer for an extended period of time, you should:

- Unplug the power supply cord or turn off electrical power to the washer.
- Turn off the water supplier to the washer.

This helps avoid accidental flooding (due to a water pressure surge) while you are away.

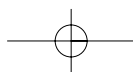

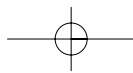

HOW TO CLEAN THE FILTER

Cleaning the water inlet filter

- Clean the filter when water leaks from the water inlet.

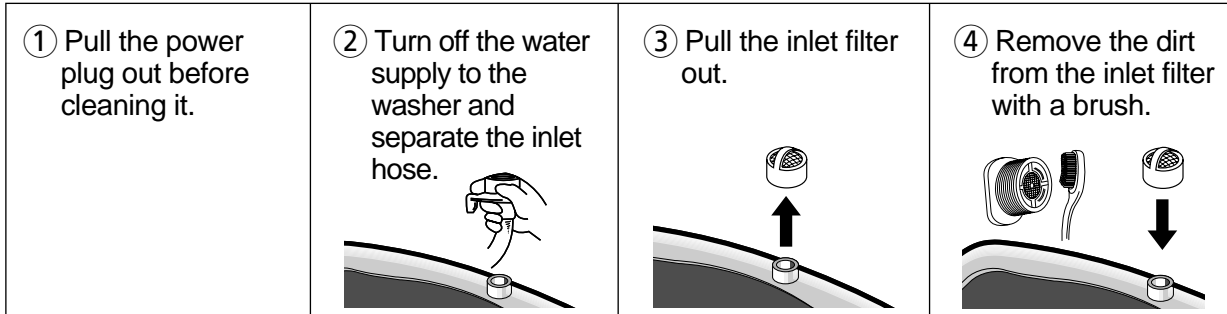

Cleaning the drain filter (For Pump Model)

- This drain filter is used to screen the foreign stuffs such as threads, coins, pins, buttons etc..
- If the drain filter is not cleaned at proper time (every 10 times of use), drain problem could be caused.

CAUTION : Be careful when draining if the water is hot.

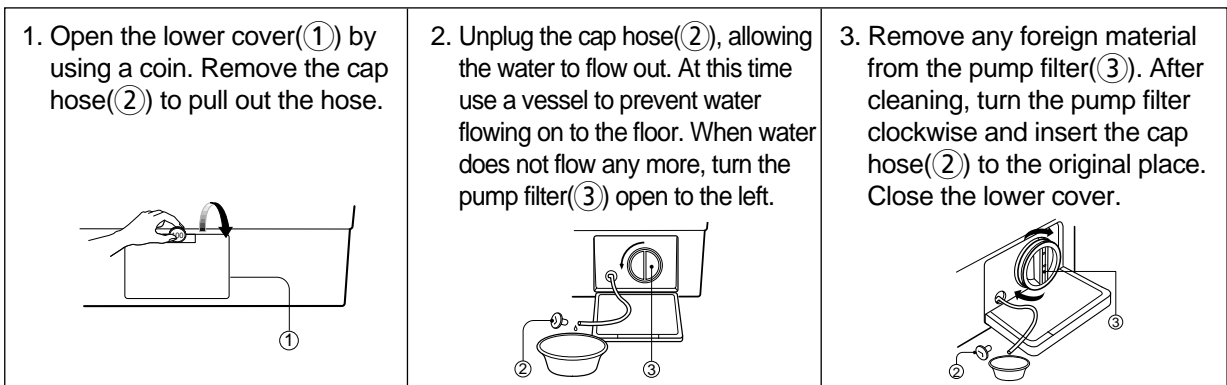

Cleaning the detergent case

*After a while detergent and fabric softeners leave a deposit in the case;

- It should be cleaned from time to time with a jet of running water.
- If necessary it can be removed completely from the machine by pressing the catch downwards and by pulling it out.
- To facilitate cleaning, the upper part of the fabric softener compartment can be removed.

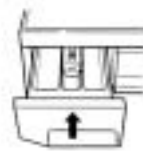
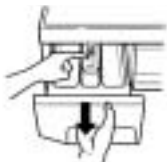

*Detergent can also accumulate inside the recess which should be cleaned occasionally with a brush.

*Once you have finished cleaning, replace the case and run a rinse cycle without laundry.

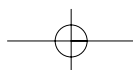

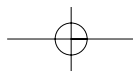

REMOVING STAINS

Stained, heavily-soiled, or greasy items may need to be prewashed or soaked for best results. Soaking helps remove protein-type stains like blood, milk or grass. Prewashing helps loosen soil before washing.

Stain removal rules

- Use warm water for soaking or prewashing stained laundry. Hot water can set stains.
- Most stains are easier to remove when they are fresh.
- Before treating any stain, find out what kind of stain it is, how old the stain is, what kind of fabric it is, and whether the fabric is colorfast. (Check the care label)
- Washing and drying can set some stains.
- Start with cold or warm water. Hot water can set some stains.
- When bleach is recommended, use a bleach that is safe for the fabric.
- Put the stained area face down on a paper towel or white cloth. Apply the stain remover to the back of the stain. This forces the stain off fabric instead of through it.

Stain removal guide

STAIN	TO REMOVE
Blood	Rinse immediately in COLD water. If stain remains, soak in cold water with an enzyme prewash.
Chewing gum	Use ice in plastic bag to harden the gum. Scrape off what you can and the sponge with white spirits.
Cocoa, Chocolate	Sponge with COLD water and soak in an enzyme prewash. If stains persist, rub in a little detergent and rinse in cold water.
Coffee	Blot up quickly and rinse out in COLD water. Rub in a little detergent and wash in the maximum temperature allowed for the fabric type.
Cream/Milk Ice cream	Rinse in COLD water and wash normally. If stain is still apparent, sponge with white spirits.
Deodorant	Rub affected area with white vinegar and then rinse out in COLD water. Sponge with white spirits. Treat stiffened areas with enzyme prewash.
Egg	Soak in a COLD enzyme prewash, rinse and wash normally.
Fabric/Softener	Rub affected area with bar soap and wash normally.
Fruit stains	Treat as soon as possible by sponging with COLD water. Rub a little detergent on the stain and wash normally.
Grass	Sponge with white spirits. Rub in an enzyme prewash and wash as normally.
Grease and oil	Lay the affected area face down on an absorbent cloth and work from the back. Sponge with white spirits or dry cleaning fluid. Wash normally.
Iron or rust	Apply lemon juice and salt and place in the sun. Wash normally.
Lipstick	Sponge with white methylated spirits and wash normally.
Mildew	Wash in WARM water and detergent. Moisten area with lemon juice, dry in the sun and wash normally. If stain persists and the fabric allows, use a bleach.
Mud	Brush off any dry mud. Rinse in cold water. If stain persists rub in a little detergent and wash normally.
Paint-oil based	Scrape off any fresh paint and sponge with a non flammable dry cleaning fluid and wash normally.
Paint-water based	Treat while still wet, rinse in WARM water and wash normally.
Scorch marks	Dampen a cloth with hydrogen peroxide, lay it over the affected area and press with a fairly hot iron.

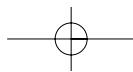

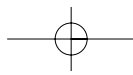

TROUBLE SHOOTING

Most problems are easily solved if you understand the cause.

Check the following list for problem before calling for service.

If the error mode such as IE, OE, UE were displayed on the control part, in order to solve these problem, first turn off the power of the washing machine and then turn on the power pressing Power button.

If PFE error mode was displayed on the control part, in order to solve this problem, first turn off the power of the washing machine, second turn on the power pressing Power button, third press SPIN button and last press Start/Hold button.

PROBLEM	CHECK POINT
<ul style="list-style-type: none"> The washer will not operate at all. 	<ul style="list-style-type: none"> Is there a power failure? Is the power cord correctly connected to an electric outlet? Did you turn on the power? Did you press Start/Hold button? Is there correct amount of laundry in the washer?
<ul style="list-style-type: none"> Water is not supplied <p>Error display IE</p>	<ul style="list-style-type: none"> Did you connect the inlet hose and open the water tap? Is the inlet hose or the water tap frozen? Is the water supply shot off? Is there any foreign matter blocking up the inlet hose filter?
<ul style="list-style-type: none"> The washer will not drain <p>Error display OE</p>	<ul style="list-style-type: none"> Is the drain hose frozen or blocked up by dirt? Is the drain hose kinked or deformed? Is the end of the drain hose immersed in water? Is there excessive dirt inside the drain filter?
<ul style="list-style-type: none"> The washer will not spin <p>Error display UE</p>	<ul style="list-style-type: none"> Is the clothes in the drum collected on one side? Is the washer installed on an uneven floor or is the vibration serious? Is the door open? (The lamp "LE" will light up in this case.)
<ul style="list-style-type: none"> The washer will stop during spinning . Spinning is insufficient. For Pump Model <p>Error display PFE</p>	<ul style="list-style-type: none"> Is the filter of the drain pump clogged? Is the drain pump operated? Did you use the proper amount of detergent? Is the drain hose placed higher than 1m above floor?
<ul style="list-style-type: none"> Vibrating and too noisy 	<ul style="list-style-type: none"> Is the washer installed on an uneven floor? Have all the transit bolts removed?

Note

- If **EB** and **ES** error mode are showed on PCB board, please contact service center.

These cases are not malfunctions;

- The sound "wing" heard during water supply is the operating sound made by the water inlet valve.

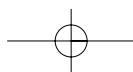

SPECIFICATION

MODEL	DWC-UD121X	DWD-UD121X
Dimension (mm)	630 x 792 x 976 (WxDxH)	
Unit Weight (kg)	82(Net) / 88(Gross)	79(Net) / 85(Gross)
Maximum Mass of Dry Cloth	Wash: 12Kg (Dry: 7Kg)	Wash: 12Kg
Standard Water Consumption	Wash: 91 ℓ (Dry: 51 ℓ)	Wash: 91 ℓ
Spin Speed (RPM)	Rinse Hold / low / medium / high / extra high	
Operating Water Pressure	0.03MPa ~ 0.8MPa (0.3kgf/cm ² ~ 8kgf/cm ²)	

WIRING DIAGRAM

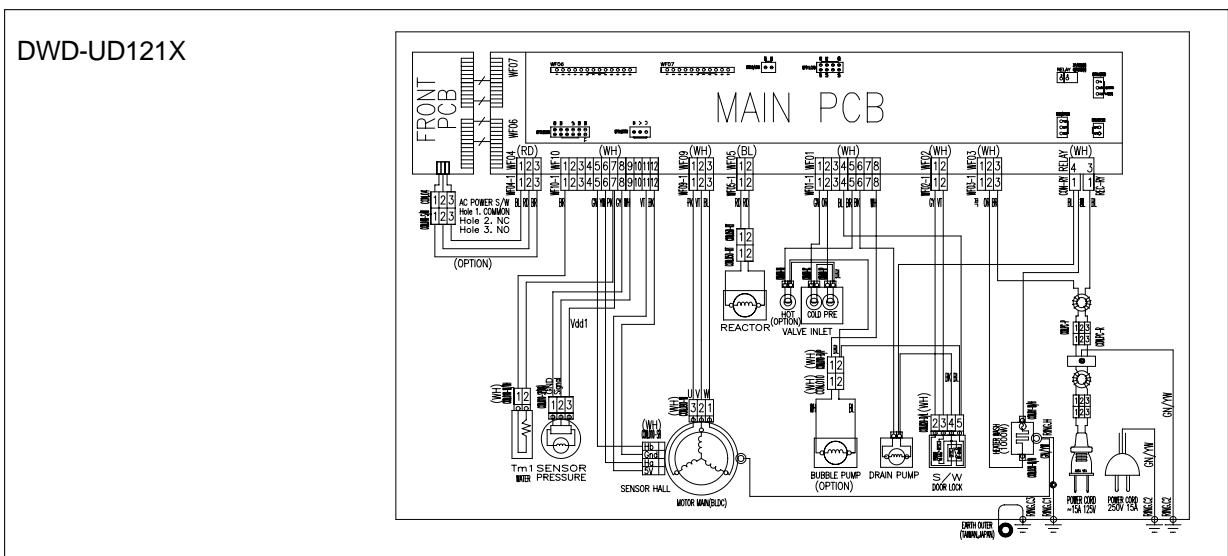
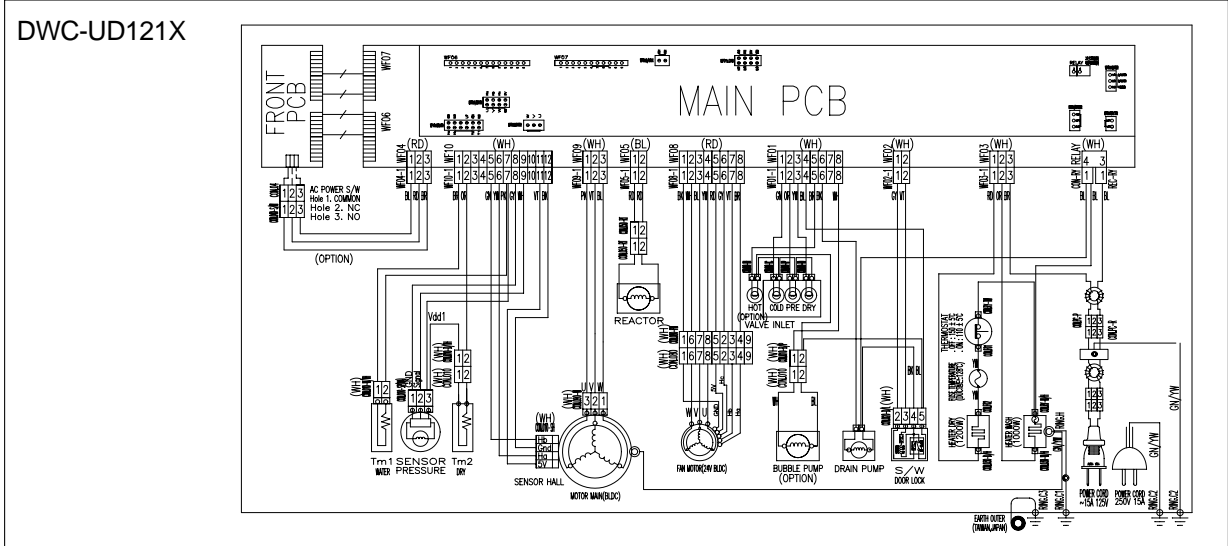

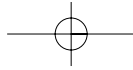

ABOUT THIS MANUAL

VISION CREATIVE, INC.

서울 종로구 통의동
6번지 이룸빌딩 4층

담 당	이영배 님 / 전은일 님	
MODEL		
BUYER	DWC(D)-UD121X(영어)	
일 정	1차	
	2차	
	3차	
	4차	
	5차	
제 판	한	인 쇄
MEMO 접수: (총32p) 08.04.28- 전체신규 32p 08.05.20- 표지, 10p, 11p, 12p, 13p, 14p, 15p, 16p, 17p, 18p, 19p, 20p, 21p, 22p, 23p, 26p, 27p, 32p 수정_ 신규 18p 08.06.02- 6p, 9p, 10p, 11p, 12p, 13p, 14p, 15p, 16p, 18p, 19p, 20p, 21p, 22p, 23p, 26p, 28p, 30p 수정_ 신규 18p 08.06.04- 11p, 12p, 13p, 17p, 19p, 21p, 22p 수정_ 신규 7p 08.07.14- 표지, 9p, 10p, 11p, 19p, 21p, 22p, 23p, 26p, 27p, 33p 수정_ 신규 11p 08.07.15- 10p, 27p 수정_ 신규 2p 08.08.22- 10p 수정_ 신규 1p 08.09.12- 2p 수정(액체세제 삭제)_ 신규 1p 08.10.14- 10p 수정_ 신규 1p		

연락처

VISION 담당 방문수

TEL: 730-0660 FAX: 730-3788

